

**HP D1194A Super VGA Display &
HP D1195A Ergonomic
Super VGA Display
Installation Guide**



HP Part No. 5960-6803
Printed in USA May 1991

HP Computer Museum
www.hpmuseum.net

For research and education purposes only.

Notice

The information contained in this document is subject to change without notice.

Hewlett-Packard makes no warranty of any kind with regard to this material, including, but not limited to, the implied warranties of merchantability and fitness for a particular purpose. Hewlett-Packard assumes no responsibility for the use or reliability of its software on equipment that is not furnished by Hewlett-Packard.

This document contains proprietary information that is protected by copyright. All rights are reserved. No part of this document may be photocopied, reproduced, or translated to another language without the prior written consent of Hewlett-Packard Company.

North American Personal Computer Division
974 E. Arques Avenue
P.O. Box 3486
Sunnyvale, CA 94086
USA

Contents

1. Installing the Display	
Introduction	1-1
What You Need	1-2
Cleaning the HP D1195A Ergonomic VGA Display Screen	1-2
Setting Up The Display	1-3
Adjusting and Controlling the Display	1-4
2. Specifications	
Timing Chart	2-2
HP D1194A	2-3
HP D1195A	2-4
A. Regulatory Information and Hardware Warranty	
Notice for the U.S.	A-1
FCC Statement	A-1
Notice for Germany	A-2
Manufacturer's Declaration	A-2
X-Ray Radiation Notice	A-2
Acoustics	A-3
Notice for United Kingdom	A-3
Notice for Canada	A-3
General Notice	A-3
Notice for Japan	A-4
Notice for Korea	A-4
Warranty	A-4
Declaration of Conformity (HP D1194 A)	A-5
Declaration of Conformity (HP D1195 A)	A-6

Installing the Display

Introduction

You can use the HP D1194A Super VGA Display or HP D1195A Ergonomic Super VGA Display with:

- a Hewlett-Packard personal computer equipped with an HP Video Graphics Adapter (VGA), Super Video Graphics Adapter, or equivalent
- an IBM PS/2 personal computer or equivalent

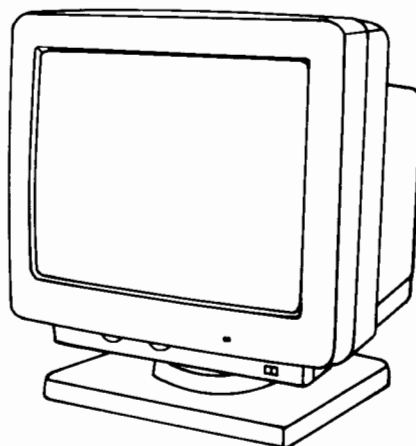

What You Need

To install the display you need:

- the HP D1194A or HP D1195A Display
- power cord
- this manual
- a medium flat-blade screwdriver

Caution



Avoid placing anything on top of the display. Objects placed on the display could obstruct ventilation and cause damage to the display.

Also, the operating site must be free from excessive heat, moisture, or electromagnetic field sources such as transformers, motors, and other equipment producing strong magnetic fields.

Leaving a “fixed pattern” continuously on the display for an extended period of time can etch the pattern into the display. When the display is not in use, turn it off, or set the contrast and brightness controls to minimum levels. A screen saver program is a useful aid in assuring long term display performance.

Cleaning the HP D1195A Ergonomic VGA Display Screen

The HP D1195A display screen has an anti-static coating which should not be cleaned with any cleaning solution containing fluoride, acids, or alkalis.

To clean the screen:

- Wet a soft cotton cloth with the cleaning solution.
- Wipe the screen *softly* with the solution.
- Dry with a clean soft cotton cloth.

Setting Up The Display

Do the following:

1. Make sure your computer and display are turned off.
2. *Deskside computer:* Place the display on a flat, sturdy surface.
Desktop computer: Place the display on top of the computer.
3. Connect the 15-pin video connector to the video adapter connection on your computer.

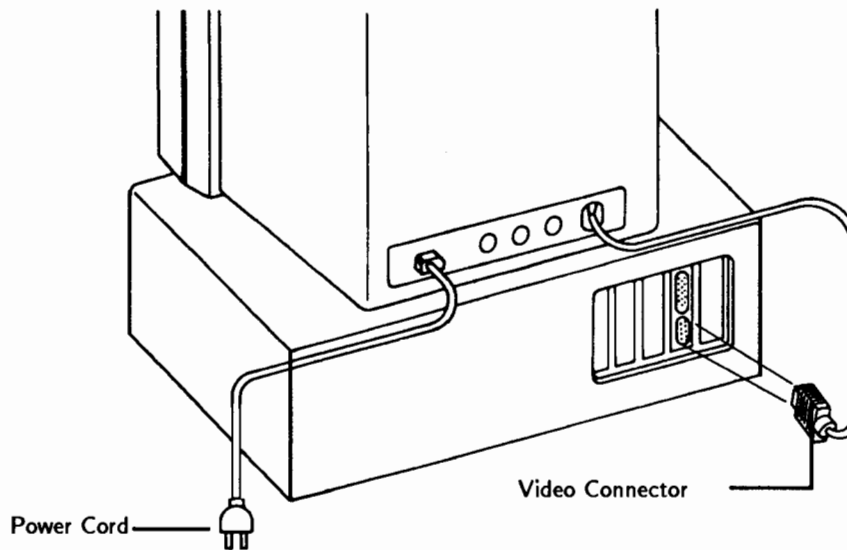

4. Connect the power cord to the display.
5. Plug the power cord into the power outlet.

The installation is complete.

Adjusting and Controlling the Display

The front of the display has the following controls:

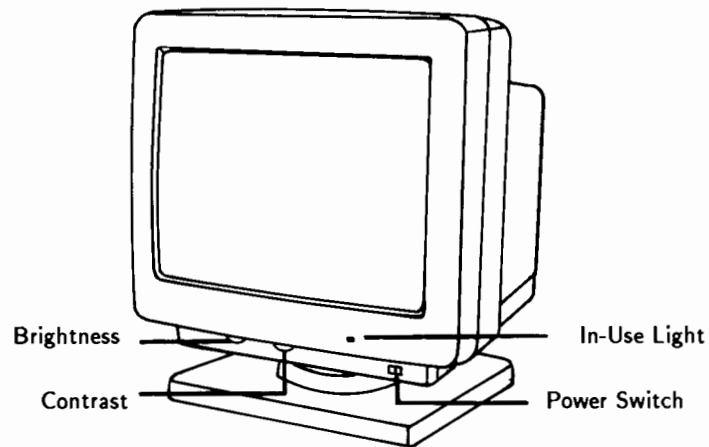

Power Switch: Turn the display on and off with this switch.

Brightness: Adjusts the image black level, setting the overall picture brightness.

Contrast: Adjusts the image white level, setting the contrast between the light and dark portions of the image.

Caution



Setting the contrast and brightness controls to their maximum level for a prolonged period can permanently damage the screen.

The back of the display has the following controls:

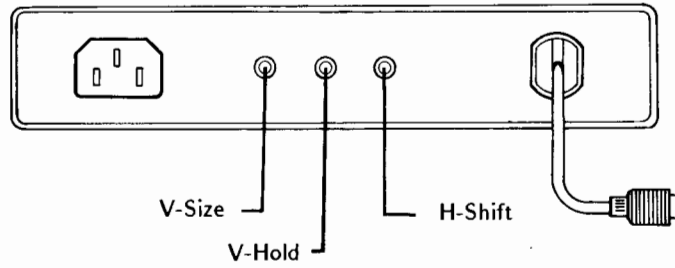

You need a small flat-blade screwdriver to adjust the following controls:

V-Size: Turn this control to adjust the vertical size.

V-Hold: Turn this control to adjust the vertical hold.

H-Shift: Turn this control to adjust the horizontal shift.

Specifications

Power Source	AC 100V to AC 240V, (50Hz/60Hz)
Power Consumption	70 Watts Maximum
Video Bandwidth	D1194A: 40MHz (-3dB) D1195A: 50MHz (-3dB)
Picture Tube	14inches, 90° Deflection
Screen Dimension (H x V)	240mm x 180mm
Phosphor/Dot Pitch	P22, 0.28mm
Colors	Unlimited
Resolution	Horizontal 800 Dots—Vertical 600 Lines
Dimensions (HxWxL)	365mm x 354mm x 372mm (with stand)
Weight (approximate)	
Net	11.5kg
Gross	14.1kg
User Controls	
Front	Contrast, Brightness
Back	H-Shift, V-Hold, V-Size
Input Terminal	15-Pin Signal Connector with Cable
Temperature	
Operating	+5°C through +40°C
Non-operating	-40°C through +70°C
Input Signals	
Video	.7Vp-p Analog (Positive)
Sync	TTL Level Separate Sync. (Negative/Positive)

Timing Chart

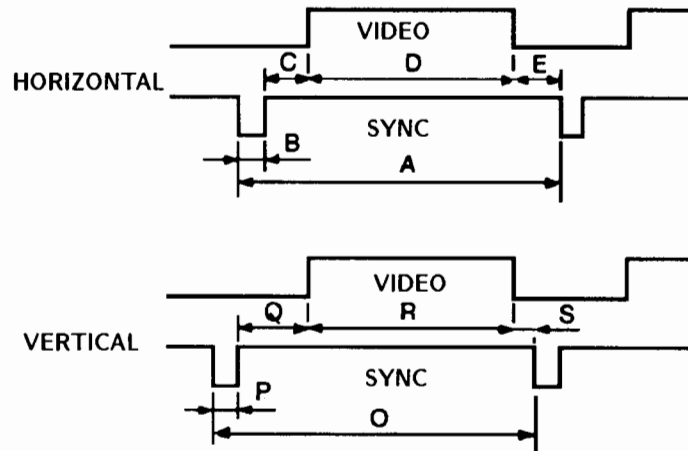

HP D1194A

Horizontal Frequency	31.5kHz			37.9kHz	
Horizontal Dots	640	640	640	640	800
Vertical Scan Lines	350	400	480	480	600
Sync. Polarity	POS	NEG	NEG	NEG	POS
A μ s	31.77	31.77	31.77	26.41	26.40
B μ s	3.77	3.77	3.77	1.27	3.20
C μ s	1.89	1.89	1.89	4.06	2.20
D μ s	25.17	25.17	25.17	20.32	20.00
E μ s	.94	.94	.94	.76	1.00
Sync. Polarity	NEG	POS	NEG	NEG	POS
Vertical Frequency	70Hz	70Hz	60Hz	72.8Hz	60.32Hz
O ms	14.27	14.27	16.68	13.74	16.58
P ms	0.06	0.06	0.06	0.08	0.11
Q ms	1.88	1.08	1.02	0.74	0.61
R ms	11.13	12.72	15.25	12.68	15.84
S ms	1.2	0.41	0.35	0.24	0.03



HP D1195A

Horizontal Frequency	31.5kHz			48.08kHz
	Horizontal Dots	640	640	640
Vertical Scan Lines	350	400	480	600
Sync. Polarity	POS	NEG	NEG	POS
A μ s	31.77	31.77	31.77	20.80
B μ s	3.77	3.77	3.77	2.40
C μ s	1.89	1.89	1.89	1.28
D μ s	25.17	25.17	25.17	16.00
E μ s	.94	.94	.94	1.12
Sync. Polarity	NEG	POS	NEG	POS
Vertical Frequency	70Hz	70Hz	60Hz	72.19Hz
O ms	14.27	14.27	16.68	13.85
P ms	0.06	0.06	0.06	0.12
Q ms	1.88	1.08	1.02	0.48
R ms	11.13	12.72	15.25	12.48
S ms	1.2	0.41	0.35	0.77

2-4 Specifications

Regulatory Information and Hardware Warranty

Notice for the U.S.

FCC Statement

Federal Communications Commission (FCC) Radio Frequency Interference Statement (USA Only)

This equipment has been tested and found to comply with the limits for a Class B digital device, pursuant to Subpart J of Part 15 of the FCC Rules. These limits are designed to provide reasonable protections against harmful interference in a residential installation. This equipment generates, uses and can radiate radio frequency energy and, if not installed and used in accordance with the instructions, may cause harmful interference to radio communications. However, there is no guarantee that interference will not occur in a particular installation. If this equipment does cause harmful interference to radio or television reception, which can be determined by turning the equipment of and on, the user is encouraged to try one of more of the following measures:

- Relocate the radio or television antenna.
- Move the computer away from the radio or television.
- Plug the computer into a different electrical outlet, so that the computer and the radio or television are on separate electrical circuits.
- Make sure that all your peripheral devices are also FCC Class B certified.
- Make sure you use only shielded cables to connect peripheral devices to your computer.
- Consult your computer dealer, Hewlett-Packard, or an experienced radio/television technician for help.

Warning

Hewlett-Packard's system verification tests were conducted with HP-supported peripheral devices and HP shielded cables, such as those you received with your system. Cables used with this computer must be properly shielded to comply with the requirements of the FCC.

Changes or modifications not expressly approved by Hewlett-Packard could void the user's authority to operate the equipment.

Notice for Germany**Manufacturer's Declaration**

This is to certify that the equipment HP D1194A/HP D1195A Video Graphics Display is in accordance with the Radio Interference Requirements of Directive FTZ 1046/1984. The German Bundespost was notified that this equipment was put into circulation; the right to check the series for compliance with the requirements was granted.

X-Ray Radiation Notice

When operating, this product emits x-rays; however, it is well shielded and meets the safety and health requirements of various countries, such as the Radiation Act of Germany and the Radiation Control for Health and Safety Act of the United States.

Radiation emitted by this product is less than 0.1 mR/hr (1 uSv/hr) at a distance of 10 centimeters from the surface of the cathode ray tube. The x-ray radiation primarily depends on the characteristics of the cathode ray tube and its associated low voltage and high voltage circuitry. Internal controls have been adjusted to ensure safe operation. Only qualified personnel should perform any internal adjustments as specified in the service manual for this product.

Replace the cathode ray tube with an identical CRT only.

**A-2 Regulatory Information and
Hardware Warranty**

Acoustics

LpA < 25 db
Operator position
Normal position
Per ISO 7779

LpA < 25 db
am Arbeitsplatz
normaler Betrieb
nach DIN 45635 T. 19

No Fan installed

Kein Ventilator eingebaut

Notice for United Kingdom

The HP D1194A/HP D1195A is approved under Approval Number NS/G/1234/J/100003 for indirect connection to public telecommunications systems within the United Kingdom.

Notice for Canada

This apparatus complies with the CLASS "B" limits for radio interference as specified in the Canadian Department of Communications Radio Interference Regulations.

Cet appareil est conforme aux normes CLASS "B" D'Interference radio tel que specifier par le Ministere Canadien des communications dans les reglements D'Interference Radio.

General Notice

HP D1195A has been tested according to MPR 1990:8 for Emissions properties and meets the guidelines as given in MPR 1990:10 (2.01 - 2.04).

Notice for Japan

この装置は、第二種情報装置（住宅地域又はその隣接した地域において使用されるべき情報装置）で住宅地域での電波障害防止を目的とした情報処理装置等電波障害自主規制協議会（VCCI）基準に適合しております。

しかし、本装置をラジオ、テレビジョン受信機に近接してご使用になると、受信障害の原因となることがあります。

取扱説明書に従って正しい取り扱いをして下さい。

Notice for Korea

이 기기는 비업무용으로 전자파 장애
검정을 받은 기기로서 주거지역에서
는 물론 모든지역에서 사용할 수
있습니다.

Warranty

Hewlett-Packard warrants this product against defects in materials and workmanship for a period of one year from receipt by the user. During this warranty period, Hewlett-Packard or an authorized dealer will, at their option, either repair or replace products that prove to be defective.

For complete information, please refer to the hardware warranty that came with your computer.

DECLARATION OF CONFORMITY

according to ISO/IEC Guide 22 and EN 45014

Manufacturer's Name: Hewlett-Packard Co.

Manufacturer's Address: 8020 Foothills Blvd.
Roseville, California 95678
U.S.A.

declares, that the product

Product Name: Video Display Monitor

Model Number: HP D1194A

conforms to the following product Specifications:

Safety: IEC 950, EN 60950

EMI: CISPR 22, EN 55022 Class B

EMC: EN 55101-2, 3kV Contact Discharge, 8kV Air Discharge
EN 55101-3, 5V/m

Ergonomics: ZH1/618

Supplementary Information:

Sunnyvale, California
Location

Date

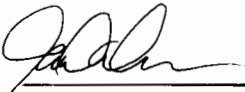

Signature / QA Manager

DECLARATION OF CONFORMITY

according to ISO/IEC Guide 22 and EN 45014

Manufacturer's Name: Hewlett-Packard Co.

Manufacturer's Address: 8020 Foothills Blvd.
Roseville, California 95678
U.S.A.

declares, that the product

Product Name: Video Display Monitor

Model Number: HP D1195A

conforms to the following product Specifications:

Safety: IEC 950, EN 60950

EMI: CISPR 22, EN 55022 Class B

EMC: EN 55101-2, 3kV Contact Discharge, 8kV Air Discharge
EN 55101-3, 5V/m

Ergonomics: ZH1/618

Supplementary Information:

Sunnyvale, California
Location

Date

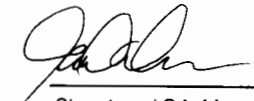

Signature / QA Manager